

Features

- High Quality High-Pressure Pump & Direct Drive Motor
- High Quality Low Pressure Boost Pump included.
- LCD Graphical Touchscreen Control
- LCD Digital Salinity Monitor
- Reliable PLC Control Unit
- Auto Divert Valve for Product Water
- Low Pressure Safety Shut-Off
- High Pressure Safety Relief
- Fresh Water Flush System
- 30 & 5 Micron Pre-Filter System
- Precision Product Flow Gauge
- Low and High Pressure Gauges
- Product Water Sample Port
- Tank Full Indication and Stop (optional tank switch required)
- Supplied with Custom Length HP Hoses (if required)
- Easy Servicing and Parts Availability
- Low Maintenance Costs
- Robust Design



AFD1200AC

Aquafresh Watermakers are hand built in the U.K and individually tested to ensure each one meets the performance requirements for volume and quality of potable water.

Every watermaker undergoes a stringent test programme to guarantee that your Aquafresh conforms to the highest standards and is delivered in perfect condition.

All of the components used on our watermakers are selected for practicality, corrosion resistance, availability and ease of replacement anywhere in the world. Quite simply your Aquafresh Watermaker has been designed and engineered with robust reliability in mind, continually supplying high quality freshwater year after year.

Our rejection and recovery rates are amongst the very best in the industry, something that our competitors often fail to mention.

Watermaker Specification AFD1200AC

Main Panel:

Length	1143mm
Height	337mm
Depth	251mm
Total Weight	80.5kg
AC Voltage	230vAC 50/60Hz
AC Power Requirement (running)	12Amps/240vAC

Water Production Rates* :

Litres / Hour	189
UK Gallons / Hour	41.6
US Gallons / Hour	49.2
Rejection Rate (salt)	99.14%
Recovery Rate (potable water)	18.97%

*Production rates based on feed water of 25°C, 35000ppm @900psi

Standard PreFilter Housing

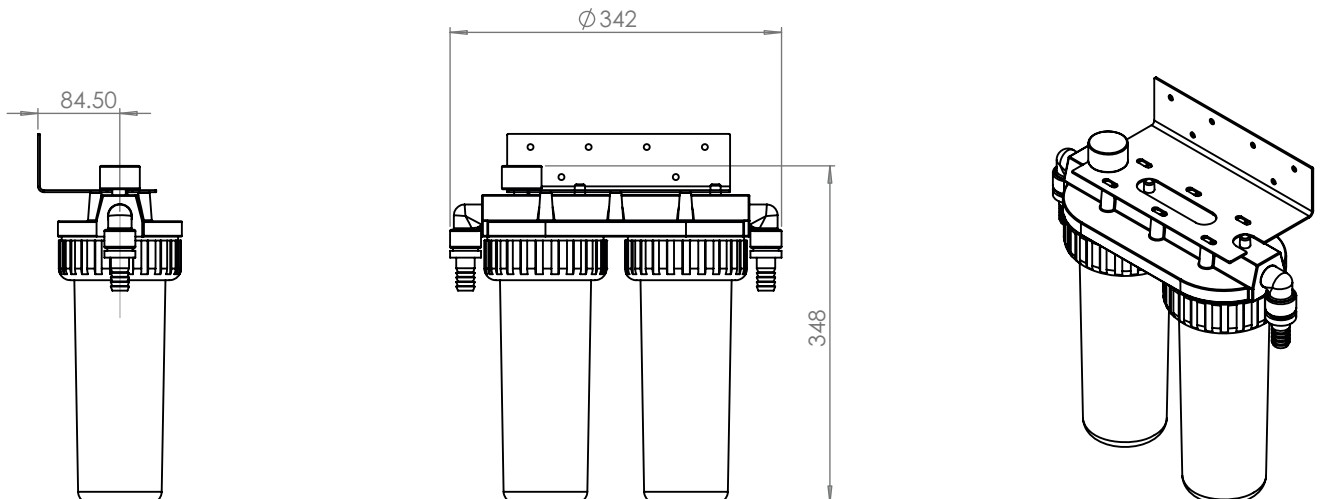

Main Panel

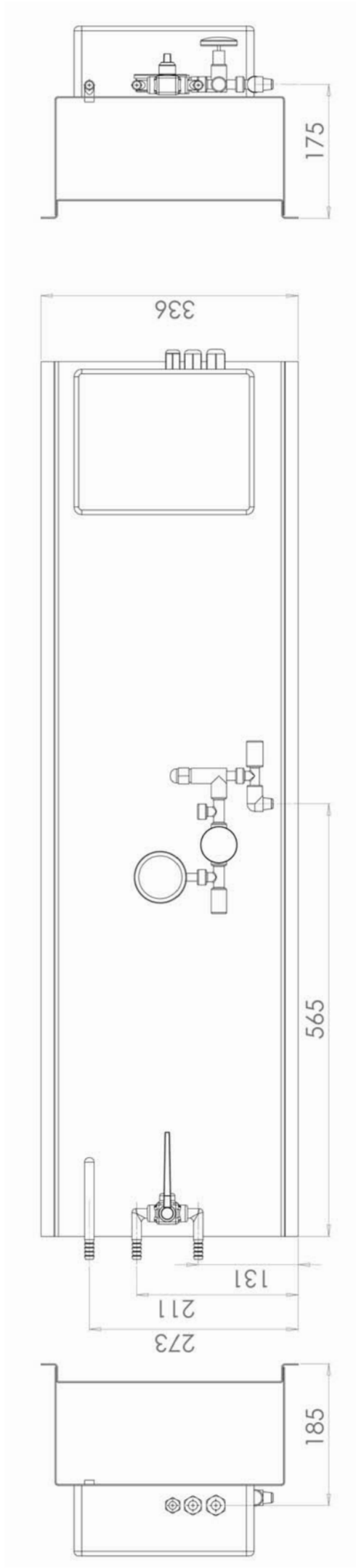
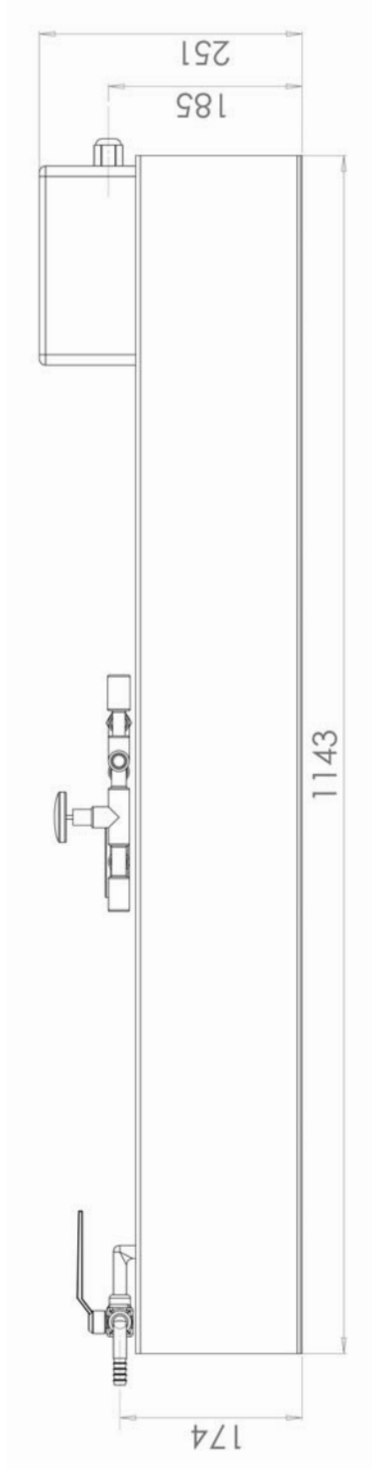

HP Feed Pump

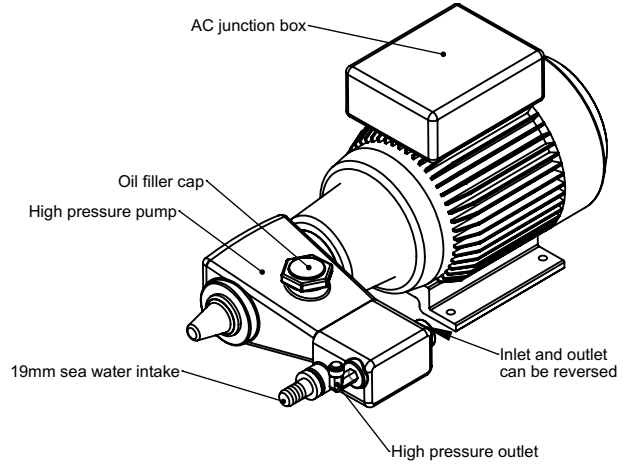
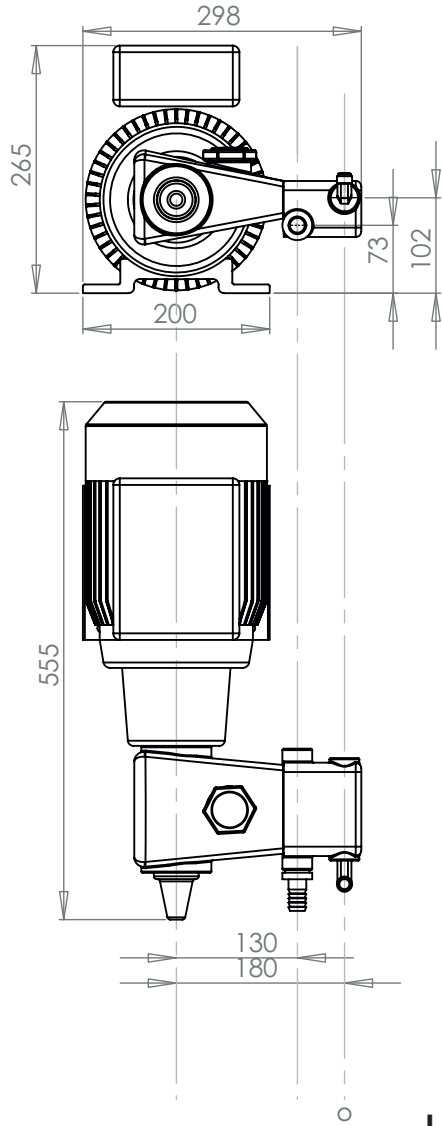

LP Boost Pump

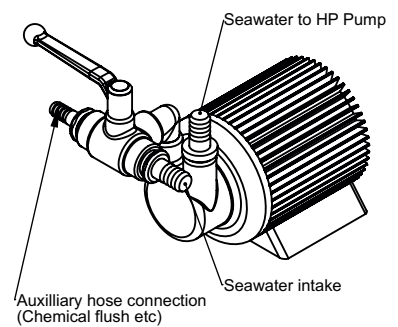
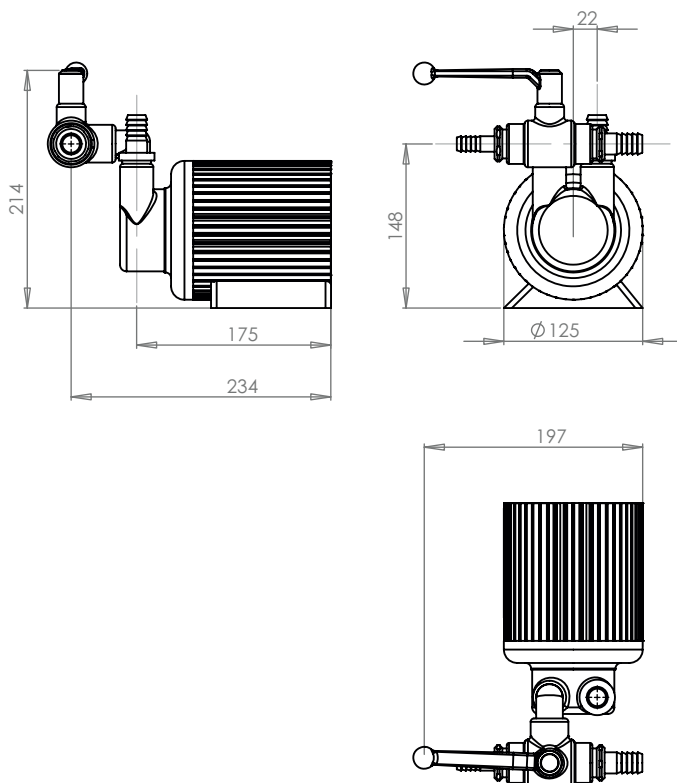

Aquafresh Watermakers Ltd.
Western Wood Way
Langage Science Park
Plymouth
Devon
PL7 5BG
U.K

Tel: +44 1752 208810
 Fax: +44 1752 208811

info@aquafreshwatermakers.com